

Обжимные пневматические инструменты (для обжимных колец) Stanley BOSTITCH

Серия инструментов - HR

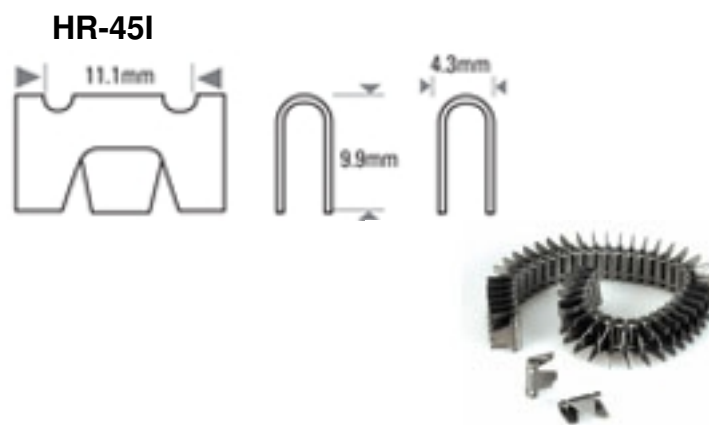

Модель: □



HR-65C-130

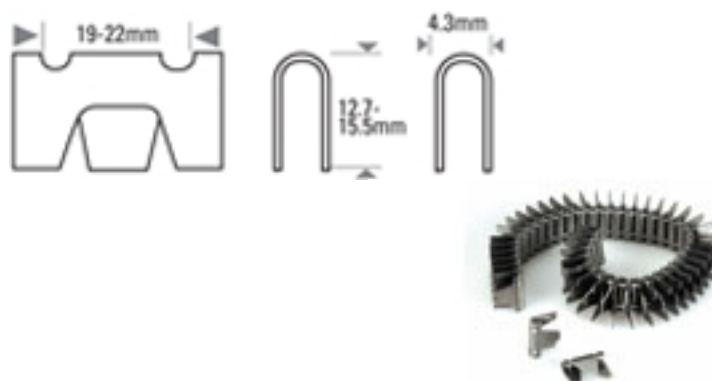

HR-66C-110



HR-68C-100



HR

-

85C-100



HR

-

85SBN



HR-86C-100



HR-86C-88B



HR

-

66C



HR-49CCP



Серия инструментов - SC



Модель: П

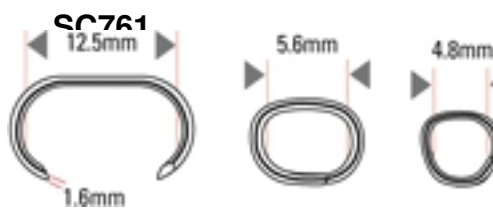
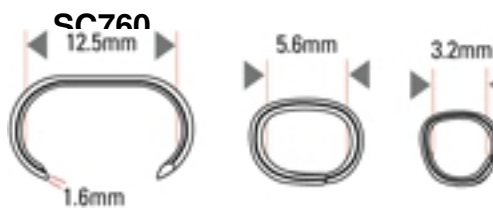
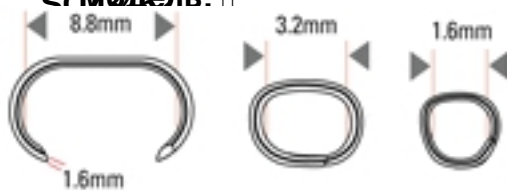



SC742

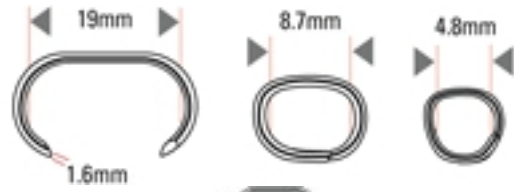

SC743



SC7



SC77XE



SC7C

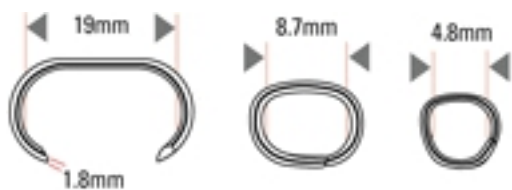

SC7E



Модель: П

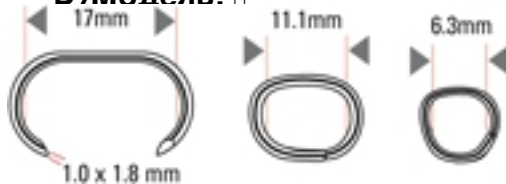

Модель: ТМ201 (ТМ203) инструмент



Вес

(кг)

Базовые размеры

мм.

Дж



МОДЕЛЬ: RINGER 9/16

Расход воздуха

л/цикл при 5,6 bar.

3.30



Вес

(кг)

Експортні розміри

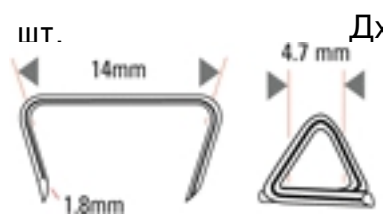

МОДЕЛЬ: HERO

Механический инструмент



Вес

(кг)

Експортні розміри

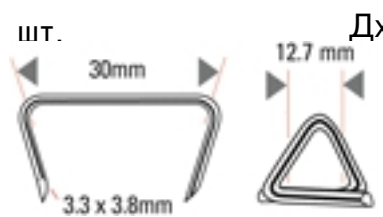

Механический инструмент